



HONDA

CLARITY

FUEL CELL

**Honda Clarity Fuel-Cell Electric Car
Emergency Response Guide**



Introduction

This guide sets out points that emergency responders should note when dealing with vehicle emergencies involving the *Clarity Fuel Cell* electric car. To help ensure that emergency response operations proceed safely, responders are asked to read this guide carefully and observe the warnings given.

The *Clarity Fuel Cell* is a fuel-cell car that uses hydrogen as fuel.

It is driven by a motor using electricity generated by the chemical reaction between the fuel-cell stack and the oxygen in the air.

It also has a lithium-ion battery that temporarily stores the electricity generated. This battery assists the motor's output during acceleration and stores the energy recovered during braking, so energy is used efficiently.

The only by-products emitted while the car is driving are water and steam. No carbon dioxide, nitrogen oxides or other exhaust gases are emitted at all.

This means that the car is environmentally friendly.



Honda Motor Co., Ltd.

Equipment that may be required

When responding to a vehicle emergency involving the *Clarity Fuel Cell*, the following equipment should be kept on hand.

- (1) Personal insulating protective equipment (insulating gloves, protective goggles, insulating boots)
- (2) ABC fire extinguisher
- (3) Solvent-resistant protective equipment; i.e., gas mask (for organic gases), chemical-resistant gloves

Particularly important safety instructions are flagged as follows. Please be sure to read these instructions.

 Danger	Failure to follow instructions will result in death or serious injury
 Warning	Failure to follow instructions could result in death or serious injury
 Caution	Failure to follow instructions could result in injury



Note: Labels bearing the high-voltage warning symbol shown on the left are affixed to high-voltage parts of the vehicle.

Contents

1. Identifying the <i>Clarity Fuel Cell</i>	2
2. About Fuel-Cell Cars.....	3
■ High-Voltage Parts.....	3
■ Isolation of High Voltage.....	4
■ Disabling the High Voltage.....	4
■ Lithium-Ion Battery.....	4
■ Fuel-Cell System.....	5
■ Fuel-Cell Stack.....	5
■ Characteristics of Hydrogen.....	6
■ Hydrogen Tanks.....	6
■ Hydrogen Filling Port and Hydrogen Pipe.....	7
■ Hydrogen Identification Labels.....	7
■ Hydrogen Supply System.....	7
■ Air Pump and Air-Pump Power-Drive Unit (PDU).....	7
■ Basic Principles of Hydrogen Safety.....	8
■ Hydrogen Safety System.....	8
■ Power Control Unit (PCU).....	9
■ Air-Conditioning System.....	9
■ FC Boost Converter.....	9
■ Dealing With Leakage of Lithium-Ion Battery Fluid.....	10
3. Precautions to be Taken When Responding to a Vehicle Emergency.....	11
■ Overview.....	11
■ Preliminary Steps.....	11
■ Securing and Stabilising the Vehicle.....	11
■ Rescuing Occupants.....	12
■ Dealing With a Vehicle Fire.....	13
■ Dealing With a Submerged Vehicle.....	13
■ Dealing With a Damaged Lithium-Ion Battery.....	13
■ Disabling the High-Voltage System.....	14
■ Precautions to be Taken When Cutting Into the Vehicle.....	17
4. Emergency Towing Procedure.....	19
■ Vehicle Information.....	19
■ Towing Method.....	19
■ Position of Tie-Down Slots.....	20
■ Position of Tow Hook.....	20
High-Voltage Warning Notice.....	End page

1. Identifying the *Clarity Fuel Cell*

The external appearance and special features of the *Clarity Fuel Cell* are outlined below. When responding to a vehicle emergency involving the *Clarity Fuel Cell*, responders are asked to observe the warnings given in this guide.

External appearance

There are identifying emblems on the front fender and on the rear of the vehicle.



Interior



The *Clarity Fuel Cell* has a fuel lid opener for hydrogen.

Identifying the *Clarity Fuel Cell* by the model number

The model number and frame number can be found on the floor at the side of the driver's seat. The three digits preceding the frame number are the model number.

Example: ZC4 – XXXXXXX (seven-digit number)

The three-digit code "ZC4" at the start of the number identifies the vehicle as a *Clarity Fuel Cell*.



To view the model number and frame number, open the cover from the front.

2. About Fuel-Cell Cars

The *Clarity Fuel Cell's* high-voltage system uses voltages of up to 500 V.

Therefore, when responding to a vehicle emergency involving this car, responders will need to deal with high voltages.

Warning

- If orange high-voltage cables or high-voltage covers have been damaged, exposing wiring, terminals or other components, the exposed parts should never be touched. Doing so could result in severe injury or death due to severe burns or electric shock.
- When it is not clear whether exposed components are high voltage or not, they should never be touched.
- If touching high-voltage cables and other high-voltage components is unavoidable, or may happen accidentally, personal insulating protective equipment (insulating gloves, protective goggles and insulating boots) should always be worn.

Equipment that may be required

When responding to a vehicle emergency involving a *Clarity Fuel Cell*, please have the following items to hand in advance.

- (1) Personal insulating protective equipment (insulating gloves, protective goggles, insulating boots)
- (2) ABC fire extinguisher
- (3) Solvent-resistant protective equipment; i.e., gas mask (for organic gases), chemical-resistant gloves

Remarks

When the vehicle emergency has been dealt with and the vehicle is to be stored in a location where no responders are present, please ensure that anyone else who will be near the vehicle is alerted to the danger, by affixing warning notices with the messages **“Undergoing high-voltage electrical work: DO NOT TOUCH!”**, and **“Undergoing high-pressure gas work: DO NOT TOUCH!”**.

(Please photocopy and use the warning notices at the back of this guide.)

■ High-Voltage Parts

The high-voltage parts of the *Clarity Fuel Cell* are shown below.

- In the illustrations, orange areas indicate high-voltage components.
- High-voltage cables can be identified by their orange colour.

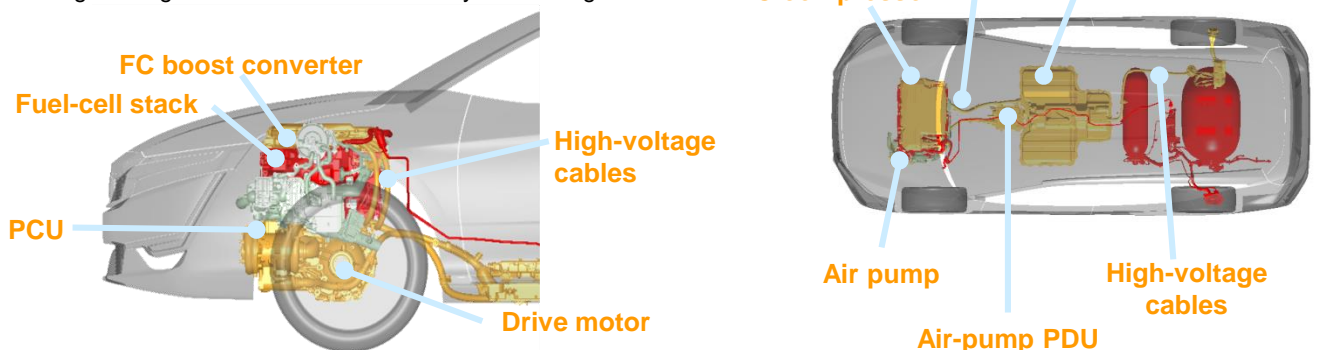

Warning

The high-voltage cables are routed under the floor, so, when the vehicle is hoisted or jacked up, care is needed to prevent anything touching these cables.

If any high-voltage cables have been damaged or broken, exposed wires will pose a risk of serious injury or death due to severe burns or electric shock.

■ Isolation of High Voltage

In the *Clarity Fuel Cell*, high voltage is isolated.

- In high-voltage circuits, both positive (+) and negative (-) poles are insulated from the vehicle body.
- High-voltage equipment and cables are provided with cases and covers to prevent exposure.
- The high-voltage cables in the motor room at the front of the vehicle are isolated by cable covers.
- High-voltage cables are distinguished by their orange colour.
- High-voltage components have warning labels affixed to them.

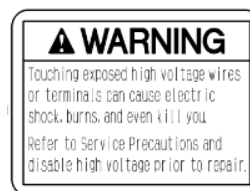

Example warning label

■ Disabling the High Voltage

The *Clarity Fuel Cell* has a system that can disable high voltage.

- The disabling of the high-voltage circuits is linked to the power switch. Turning the power switch OFF disables the high-voltage circuits.
- When an impact triggers a signal from the airbag control unit, the current cut-off switch disables the high voltage from the battery and the fuel-cell system control unit.

■ Lithium-Ion Battery

In addition to a 12 V automobile battery, the *Clarity Fuel Cell* has a lithium-ion battery (drive battery) with a nominal maximum voltage of 346 V. Housed in a waterproof case that prevents water seeping in from outside, the lithium-ion battery is stored under the floor in the centre of the vehicle.

This means that the lithium-ion battery body is normally hidden from view.

The battery electrolyte liquid is sealed inside the lithium-ion battery, and there is no need for it to be replaced or replenished.

In the unlikely event that the lithium-ion battery is damaged, there is no danger of electrolyte liquid pouring out in large quantities.

Instructions for dealing with leakage are given on page 10.

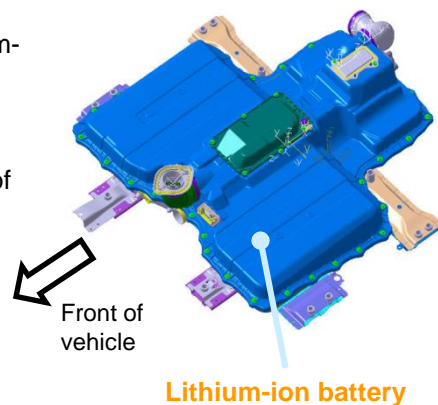

Danger

- If damage to the vehicle has exposed structural components inside high-voltage parts, or the conductive parts of high-voltage wires, such parts should never be touched. Failure to observe this precaution could result in death or serious injury.
- If touching high-voltage cables and other high-voltage components is unavoidable, or may happen accidentally, personal insulating protective equipment (insulating gloves, protective goggles and insulating boots) should always be worn.
- If lithium-ion battery electrolyte liquid comes in contact with your eyes or skin, rinse immediately with large quantities of water, and seek medical attention. There is a risk of loss of eyesight, or injury.

Fuel-Cell System

Because the *Clarity Fuel Cell* uses hydrogen to generate electricity, it is equipped with hydrogen-holding components including a fuel-cell stack, hydrogen tanks, a hydrogen filling port, a hydrogen pipe and a hydrogen supply system. **(Hydrogen-holding components shown in red)**

Warning labels drawing attention to the need for handling precautions are affixed to hydrogen-storing and other components.

Components using high voltages include the fuel-cell stack, the air pump, the air-pump PDU and the FC boost converter. **(High-voltage components shown in orange)**

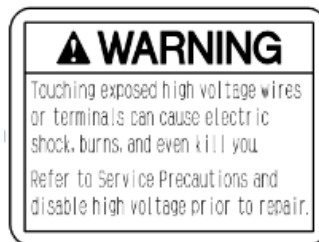
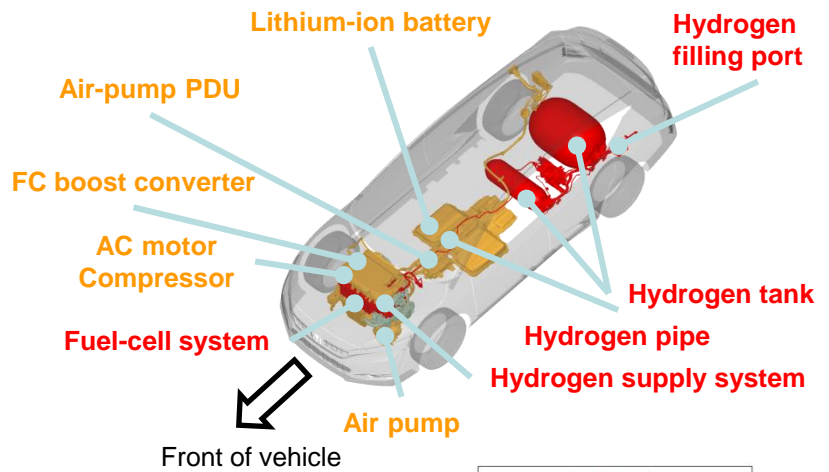

Label on top of fuel-cell system

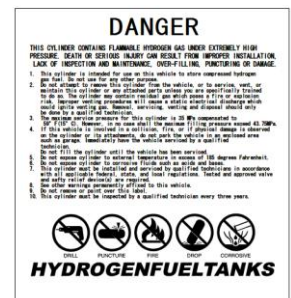

Label on outside of hydrogen tank

Fuel-Cell Stack

The *Clarity Fuel Cell* uses the chemical reaction between hydrogen and air (oxygen) to generate electricity and water. Electric cells are linked together in series to generate the high voltage and high current required by the drive motor. Several hundred electric cells linked in series are called a “fuel-cell stack”.

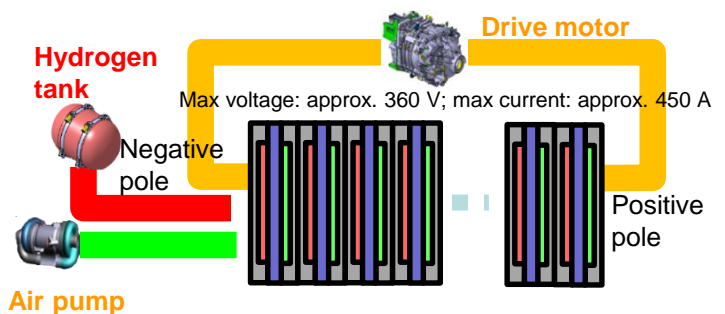
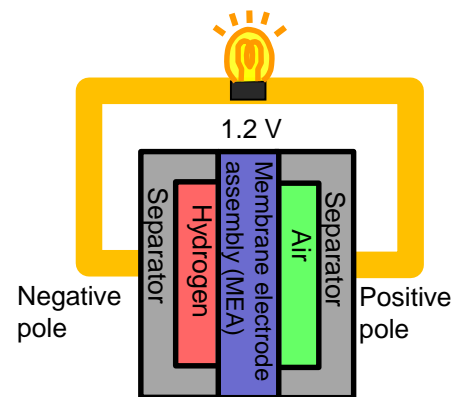
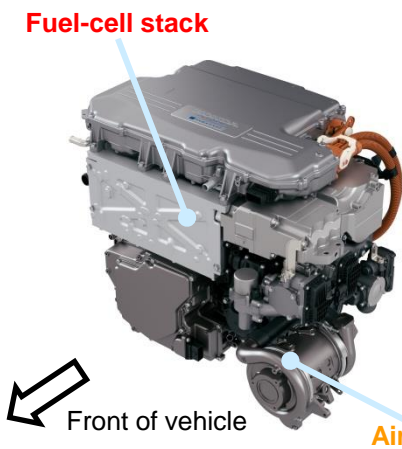

An aluminium cover ensures that the high-voltage components are unlikely to be touched accidentally.

■ Characteristics of Hydrogen

Hydrogen is a non-toxic, invisible, odourless gas. It is also lighter than air, so it tends to rise and disperse immediately in the atmosphere. As long as hydrogen's characteristics are understood, and it is handled correctly, it is not a dangerous fuel. When responding to a vehicle emergency involving this car, responders need to be aware that hydrogen flames are transparent, and produce very little radiant heat, which makes them difficult to detect.

	Gasoline (liquid)	LPG (gas)	Hydrogen (gas)	Remarks
Toxic	Yes	No	No	May cause oxygen deficiency if inhaled in large quantities
Colour	Orange	No	No	Detected by leakage sensor
Has a smell	Yes	Yes	No	
Lightness	Heavier than air	Heavier than air	Lighter than air	Disperses rapidly
Tendency to build up	Has a strong tendency to build up in enclosed spaces	Disperses through gaps	Disperses through gaps	
Ease of ignition	—	Similar to that of gasoline	Ignites more easily than gasoline	Ignites easily; flames are difficult to detect, but easy to extinguish
Detectability of flames	Easily detectable (flames are orange and give out lots of radiant heat) Orange	Fairly difficult to detect (flames are blue and give out medium amounts of radiant heat)	Difficult to detect (flames are transparent and give out little radiant heat)	
How to extinguish flames	Fire-extinguisher required	<ul style="list-style-type: none"> Shut off supply Flames can be extinguished with water 	<ul style="list-style-type: none"> Shut off supply Flames can be extinguished with water 	

■ Hydrogen Tanks

The high-pressure hydrogen gas that is used as fuel by the *Clarity Fuel Cell* is stored in hydrogen tanks capable of holding up to 70 MPa. The two hydrogen tanks, made from a non-combustible material, are stored under the floor.

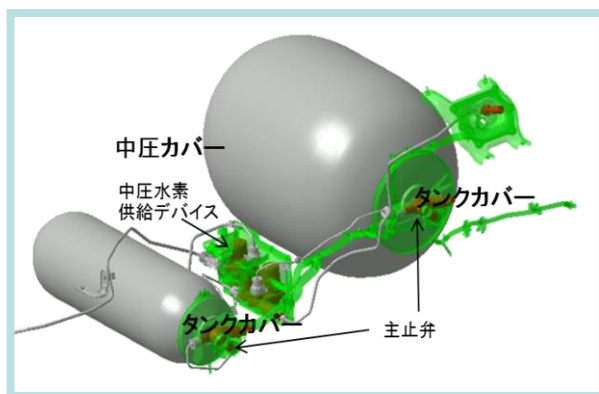
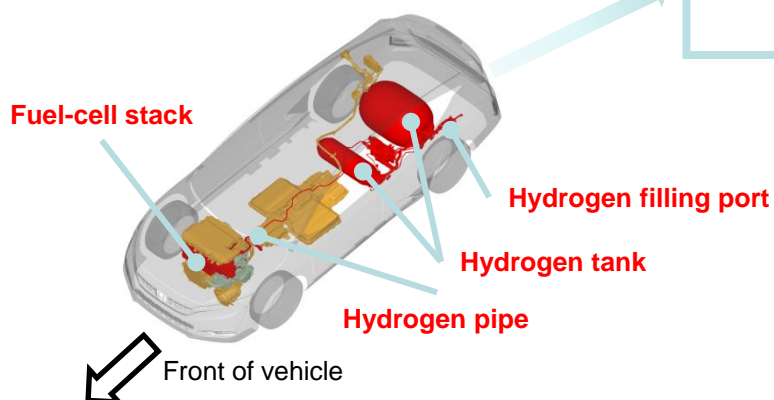

Hydrogen Filling port and Hydrogen Pipe

In the *Clarity Fuel Cell*, the hydrogen filling port on the left side of the vehicle is connected by metal hydrogen pipes to the two hydrogen tanks and the fuel-cell stack.

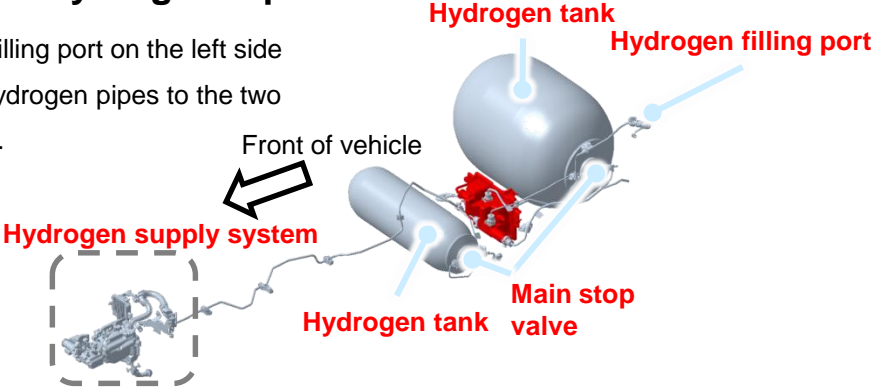

Hydrogen Identification Labels

In the *Clarity Fuel Cell*, labels are affixed to high-pressure hydrogen pipes so that they can be identified.

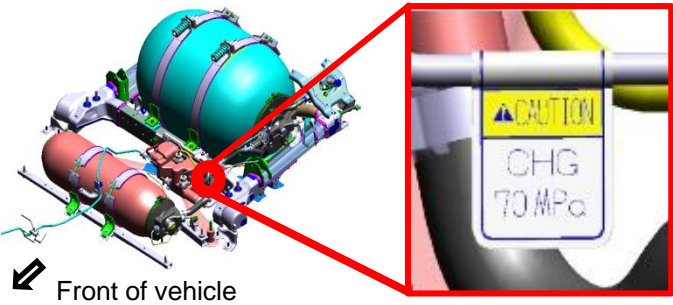

Hydrogen Supply System

In the *Clarity Fuel Cell*, the hydrogen supply system, which supplies and circulates hydrogen to the fuel-cell stack, is positioned on the left side of the fuel-cell stack, and shielded by a metal cover.

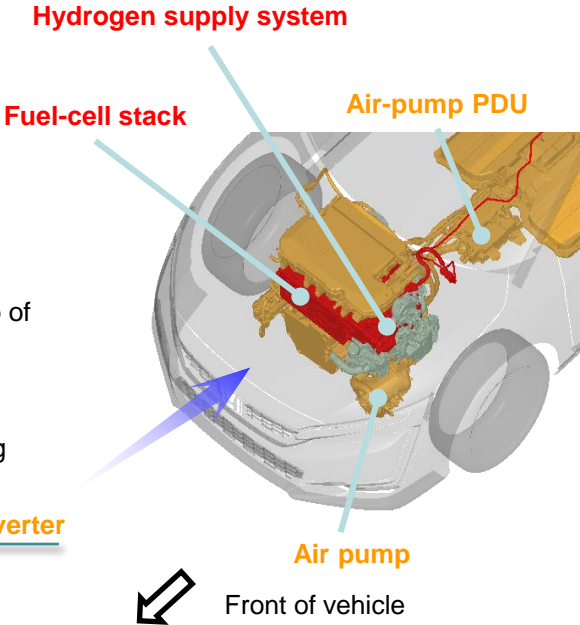

Air Pump and Air-Pump Power-Drive Unit (PDU)

In the *Clarity Fuel Cell*, the air pump is positioned on top of the front sub-frame.

The air-pump PDU, positioned towards the front of the underfloor tunnel, controls the power to the motor driving the air pump.

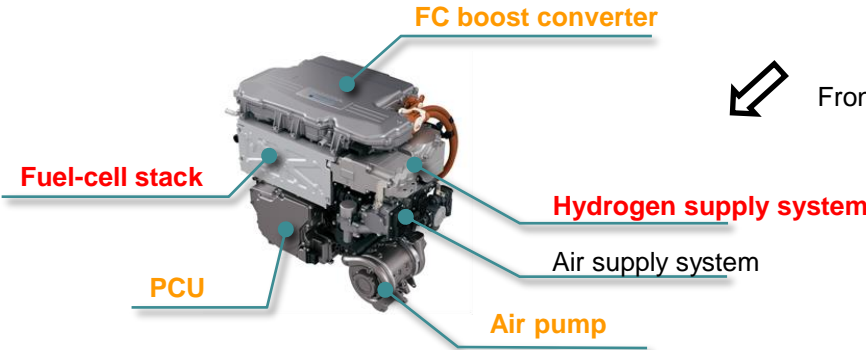

■ Basic Principles of Hydrogen Safety

Based on principles of hydrogen safety, the design of the *Clarity Fuel Cell* ensures vehicle safety.

• Preventing leakage

The components that hold the hydrogen are designed to ensure that no leakage will occur in scenarios ranging from normal use to vehicle impact (legal crash mode).

Additionally, the components that hold the hydrogen are stored inside covers that protect them from various kinds of environmental stress.

• Stopping any leakage that occurs

In the unlikely event that hydrogen leakage occurs while the vehicle is in use, a hydrogen sensor detects it and activates the main stop valve, minimising the increase in hydrogen concentration.

The vehicle is equipped with a system that detects the G-force of an impact, and shuts down the hydrogen supply system, so that in the unlikely event of damage to the hydrogen-storing components, the quantity of hydrogen leakage is minimised.

• Discharging leaked hydrogen

The design ensures that any leaked hydrogen is isolated from any potential cause of ignition and discharged safely to the outside.

■ Hydrogen Safety System

In the *Clarity Fuel Cell*, hydrogen is supplied when the fuel-cell system is in the activated state. There is a system that cuts off the supply of hydrogen in the unlikely event of a vehicle impact or a hydrogen leak.

• Hydrogen supply

When the power switch is pressed, hydrogen is supplied, and the fuel-cell system is activated.

• Hydrogen leakage detection and cut-off system

The hydrogen sensors monitor for hydrogen leakage, and if any leakage is detected, the system cuts off the supply of hydrogen. The hydrogen sensors are located inside the hydrogen holding zone.

(There are two sensors inside the motor room, and one inside the filling lid.)

• Impact-triggered cut-off system

The vehicle has a system that cuts off the hydrogen supply in the event of an impact powerful enough to activate the airbags.

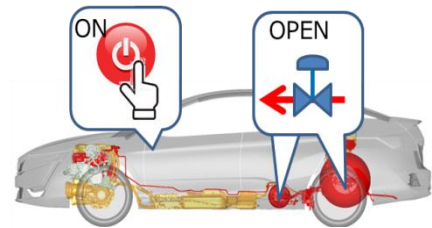

Hydrogen sensor

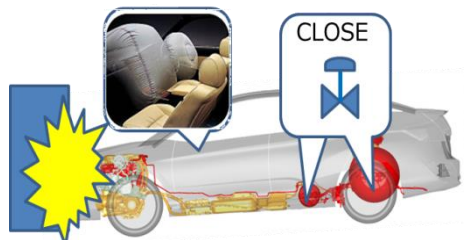
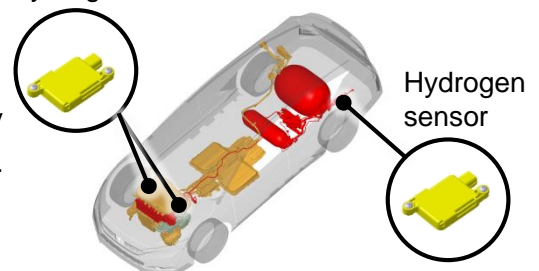

■ Power Control Unit (PCU)

In the *Clarity Fuel Cell*, the drive motor and PCU are located in the motor room towards the front of the vehicle.

The drive motor is driven by a high voltage of up to 500 V, supplied by the fuel-cell stack and the lithium-ion battery.

Fixed to the vehicle-front side of the drive motor, the PCU is a high-voltage component integrating the functions of an inverter and a lithium-ion battery converter.

Both the drive motor and the PCU are protected by housings that prevent water getting in from outside.

Additionally, all high-voltage components are insulated inside their housings, so, in normal circumstances, touching the surface of a housing will not result in an electric shock.

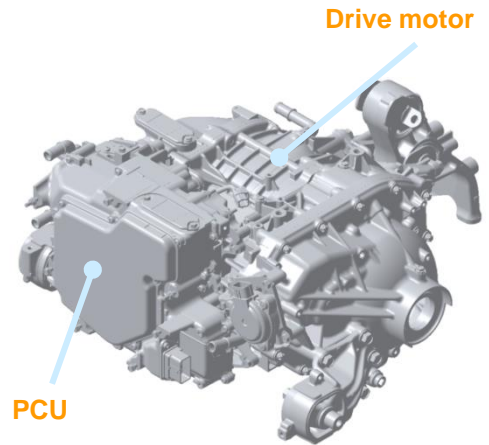

■ Air-Conditioning System

The *Clarity Fuel Cell* has a built-in air-conditioning system that runs off a high-voltage power source.

The electric compressor and hydrogen heater operate at high voltage.

Power is supplied from the lithium-ion battery to the high-voltage components via high-voltage cables.

The electric compressor and hydrogen heater are housed inside the motor room towards the front of the vehicle.

In both cases, the housing surface can be touched without receiving an electric shock.

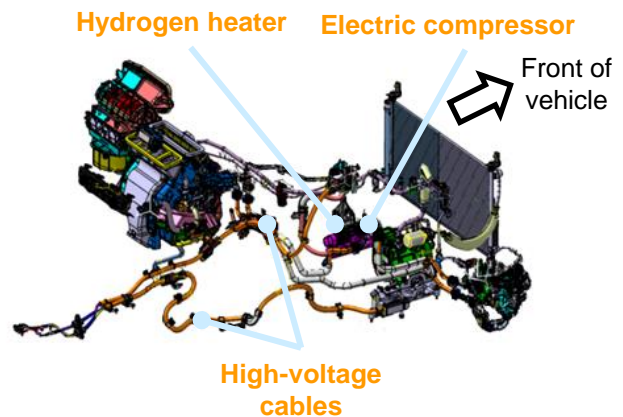

■ FC Boost Converter

In the *Clarity Fuel Cell*, the drive motor and PCU are located in the motor room towards the front of the vehicle.

Inside its housing, the FC boost converter has a converter function that boosts the output voltage of the fuel-cell stack to a maximum of 500 V, and a fuel-cell stack current cut-off switch.

The FC boost converter housing prevents water getting in from outside.

Also, because the high-voltage components are insulated inside the housing, touching the housing surface will not result in an electric shock in normal circumstances.



■ Dealing With Leakage of Lithium-Ion Battery Fluid

The electrolyte fluid in the *Clarity Fuel Cell's* lithium-ion battery is a volatile organic solvent, so it is toxic to the human body. It is colourless and transparent, which makes it difficult to distinguish by eye alone.

If leaked fluid, which may or may not be battery electrolyte fluid, is observed near the lithium-ion battery, be sure to wear solvent-resistant protective equipment; i.e., a gas mask (for organic gas) and chemical-resistant gloves.

In the unlikely event that electrolyte fluid comes in contact with your eyes or skin, immediately rinse the affected area with large quantities of water and seek medical attention.

3. Precautions to be Taken When Responding to a Vehicle Emergency

■ Overview

The *Clarity Fuel Cell* has built-in high-pressure hydrogen tanks and a lithium-ion battery.

Precautions are needed regarding the high-pressure gas and high voltages unique to fuel-cell cars.

Responders are requested to read the following section carefully and take appropriate action when engaged in actual emergency responses.

■ Preliminary Steps

Open the power windows, power seats, doors and boot, as required.

Important

If the 12 V battery has been disconnected, the operations listed above will not be possible.

■ Securing and Stabilising the Vehicle

As with a conventional vehicle, the parking brake should be applied. The vehicle should be stabilised further by placing wooden blocks or other supports underneath it, or by letting air out of the tyres, or by using rescue lifting airbags or other means.

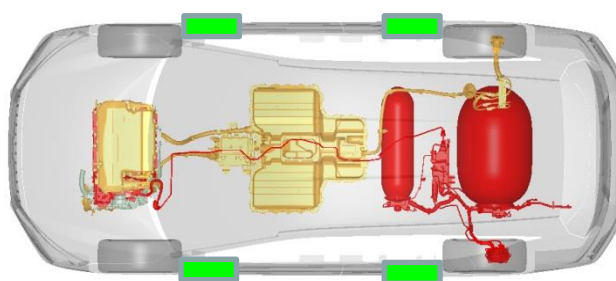

View from above

 Jack-up points

Parts shown in red:
hydrogen-holding parts

Parts shown in orange:
high-voltage parts

Warning

The supports or rescue lifting airbags should be positioned so as to avoid the underfloor high-voltage components, hydrogen tanks, hydrogen pipes and exhaust system.

This is because death or serious injury could result if fire is ignited by damage to high-voltage cables, or damage to or heating of the hydrogen pipe, or if the lifting airbags are damaged, and so on.

■ Rescuing Occupants

If you need to make room to rescue a passenger seated in the front seat, adjust the position of the steering wheel.

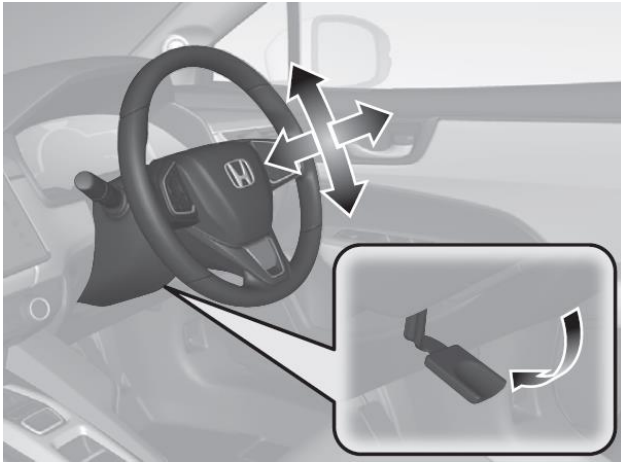

Similarly, adjust the position of the front seat if more space is required.

■ Adjusting the headrest

- Pull upward to raise the headrest higher.
- To lower the headrest, press the headrest downward while pressing and holding the knob.

■ Reclining the backrest
Push the switch forward and backward to recline the backrest.

A ■ Adjusting the height of the driver's seat
Push the switch upward and downward to adjust the seat's height.

B ■ Adjusting the horizontal position
Push the switch forward and backward to adjust the horizontal position.

A central grayscale illustration of a car seat with various adjustment arrows. A vertical double-headed arrow is on the headrest. A curved arrow on the backrest indicates reclining. A horizontal double-headed arrow is on the seat base. Three callout boxes show close-ups of the adjustment controls: the headrest knob, the reclining switch, and the seat height/position switch. The height/position switch is shown in three states: raised (labeled 'A'), lowered (labeled 'A'), and moved horizontally (labeled 'B').

■ Dealing With a Vehicle Fire

The *Clarity Fuel Cell* carries flammable, highly pressurised hydrogen gas.

The hydrogen tank at the rear of the vehicle should be hosed with large quantities of water to cool it down. If a fire breaks out and the temperature and pressure inside the tank rise to abnormally high levels, the fusible plug valve fitted on the tank will open, releasing hydrogen from the rear of the vehicle.

When extinguishing the fire, move away from the vehicle before applying the hose, in case the discharged hydrogen catches fire. Approach the vehicle from a 45° angle.

If the discharged hydrogen catches fire, wait until all the hydrogen has escaped and the heat of the flames has subsided before attempting to extinguish the blaze. Instead, hose the surrounding area to cool it down and prevent the fire from spreading.

If you attempt to extinguish the blaze while hydrogen is still escaping, there is a risk that the unburned hydrogen may build up and explode.

Generally speaking, hydrogen flames are colourless and give out little radiant heat, which makes them difficult to detect visually. However, in the event of a vehicle fire, combustible items around the vehicle burn as well, and those flames will be coloured, making them easy to see.

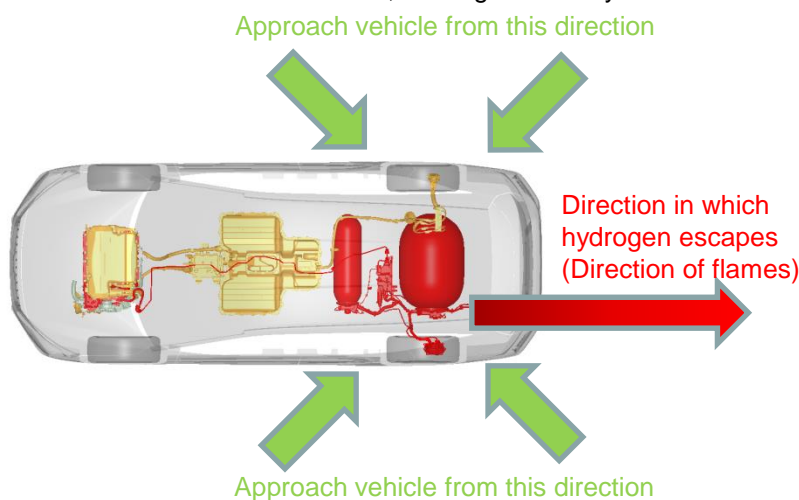

■ Dealing With a Submerged Vehicle

If the vehicle is submerged in water, circuits will be shorted, causing the power system fuse and the lithium-ion battery's main fuse to blow, cutting off the voltage.

In cases where the water is shallow, or the vehicle is only partially submerged, some circuits have not been shorted, and those parts may still retain a high voltage. So, as far as possible, follow the procedure outlined in "How to Disable the High-Voltage System" on page 14.

■ Dealing With a Damaged Lithium-Ion Battery

In the unlikely event that the lithium-ion battery has been damaged — by impact, for example — never touch exposed terminals, metal components or high-voltage cables. If touching such parts is unavoidable, or may happen accidentally, personal insulating protective equipment (insulating gloves, protective goggles and insulating boots) should always be worn.

If there is fluid that may or may not have leaked from the battery, follow the procedure given in "Dealing With a Damaged Lithium-Ion Battery" on page 10.

■ How to Disable the High-Voltage System

The best way to disable the high voltage depends on the situation. Any of the following methods can be used. Once the high voltage has been disabled, normal emergency response procedures can be carried out. The flowchart below shows how to select the easiest method.

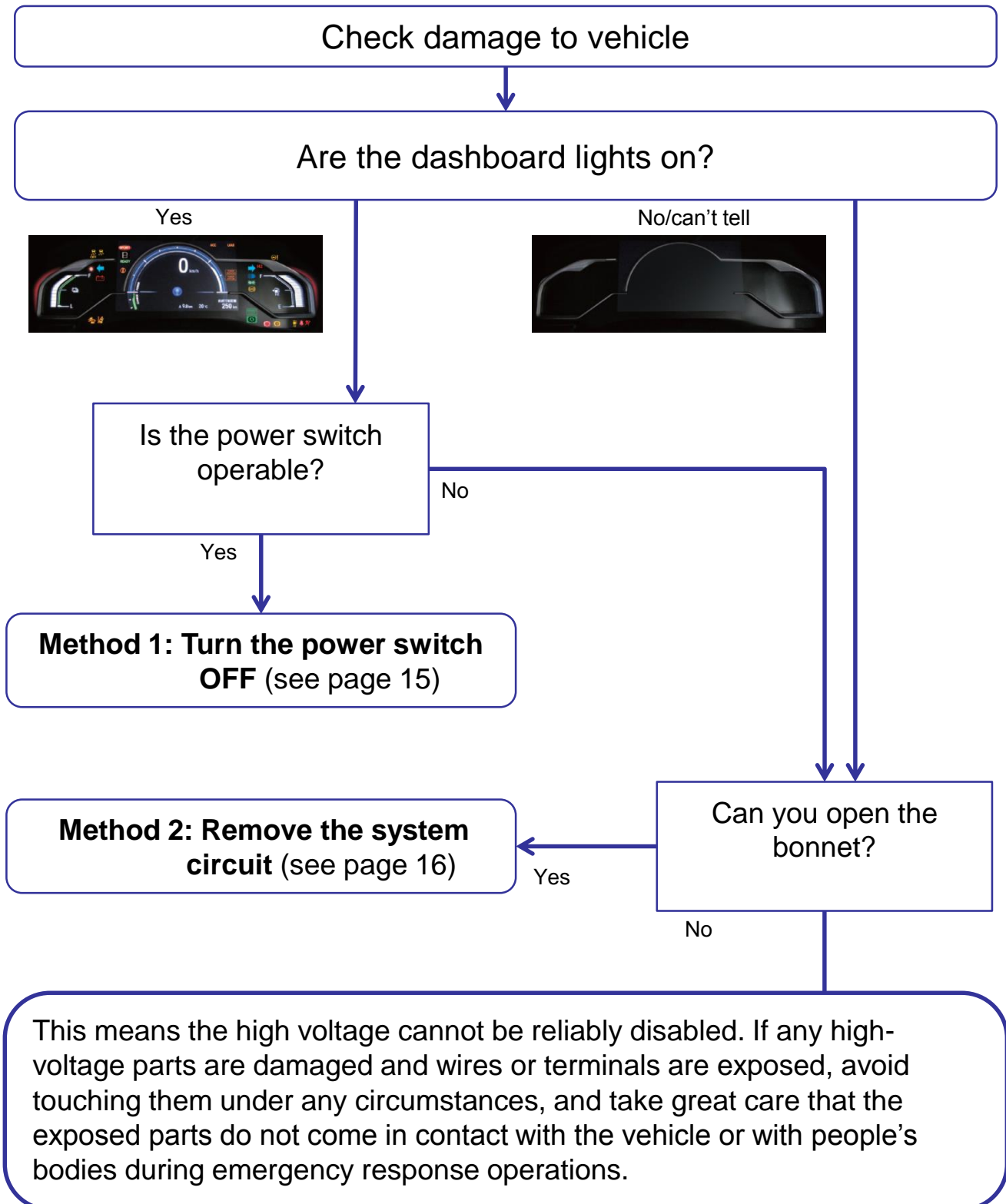

Method 1: Turn the power switch OFF

◆ If the power switch can still be operated, despite damage to the vehicle:

Turn the power switch OFF

- (1) Put the shift lever in the "P" position.
- (2) Turn the power OFF by pressing the power switch for at least 2 seconds.

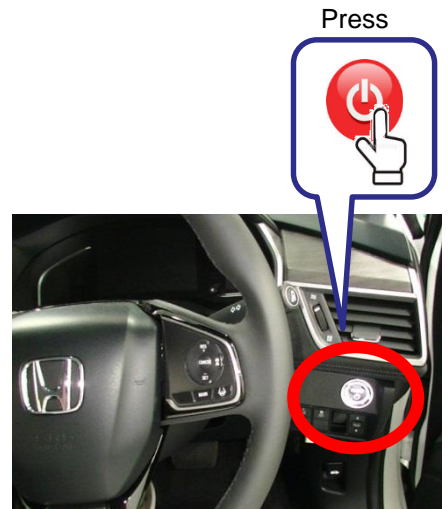

Caution

Operating the power switch while the dashboard lights are off can sometimes activate the system.

Make sure all the dashboard lights are off.

Note: To avoid unintentionally restarting the vehicle, make sure the keyless remote control is at least 6 metres away from the vehicle.

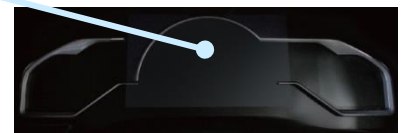

Caution

Power generation can sometimes continue even after the power switch has been turned OFF. In this case, the Multi Information Display will show a message saying "Shutting down fuel cell (FC) system. System will shut down automatically when processing is completed".

While this message is displayed, the system cannot be shut down, so wait until the message disappears.

Even when the system has been shut down, it still takes about 5 minutes for the electrical charge stored in the condenser and other parts to be discharged.

After disabling the high voltage, you still need to take full precautions against short-circuiting and other electrical hazards.

Start emergency rescue procedures

3. Precautions to be Taken When Responding to a Vehicle Emergency

Method 2: Remove the system circuit

◆ If the power switch is not operable, but the bonnet can be opened:

Open the bonnet

To open the bonnet, locate the bonnet release knob, which is by the driver's seat, and pull it towards you. When the bonnet is released, unlock it by pressing the lever at the centre front of the bonnet, then lift it open. If this procedure cannot be carried out, force the bonnet open with a crowbar or other tool. If possible, use the vehicle's own bonnet stay to secure the bonnet in the open position.

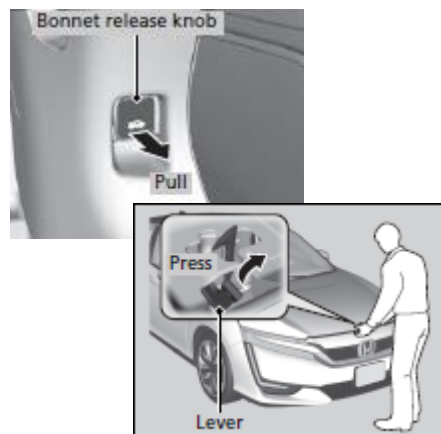

Disconnect the 12 V battery

Disconnect the cable from the negative (-) side of the 12 V battery.
Note: In order to disable the power supply to the high-voltage circuits, you need to cut the electrical connection between the battery and the main fuse inside the fuse box.
The system cannot be shut down just by disconnecting the cables from the positive (+) and negative (-) terminals of the 12 V battery.

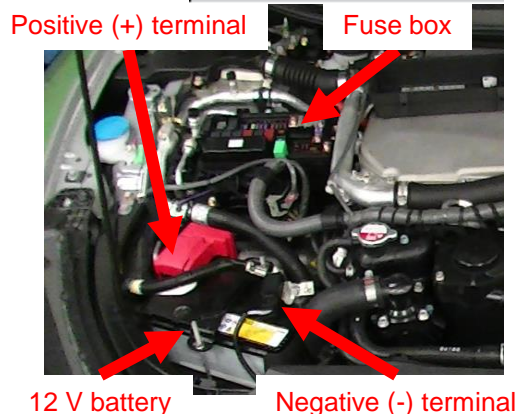

Remove the fuse from inside the fuse box

To shut down the system, remove the fuse box cover, then remove (or cut) the main fuse shown at the right in the photo.

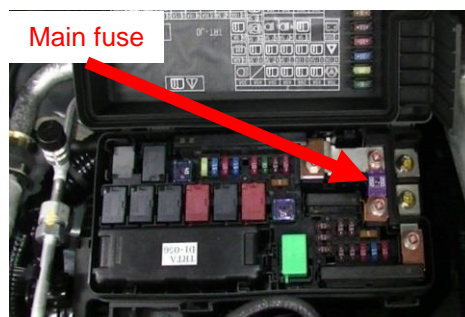

⚠ Caution

Even when the system has been shut down, it still takes about 5 minutes for the electrical charge stored in the condenser and other parts to be discharged. After disabling the high voltage, you still need to take full precautions against short-circuiting and other electrical hazards.

Start emergency rescue procedures

■ Precautions to be Taken When Cutting Into the Vehicle

Warning

- If orange high-voltage cables or high-voltage covers have been damaged, exposing wiring, terminals or other components, the exposed parts should never be touched. To do so could result in serious injury or death due to severe burns or electric shock.
- When it is not clear whether exposed components are high voltage or not, they should never be touched.
- If touching high-voltage cables and other high-voltage components is unavoidable, or may happen accidentally, personal insulating protective equipment (insulating gloves, protective goggles and insulating boots) should always be worn.
- Do not cut into the hydrogen pipes or high-voltage parts.
- To avoid the risk of serious injury due to fire caused by a spark from rescue equipment, use hydraulic cutters or other spark-free tools.
- Even when the power switch has been turned OFF and the 12 V battery has been disconnected, you need to wait at least 3 minutes before using cutters on the airbag system.

◆ Precautions regarding the airbag system

When cutting into the vehicle to rescue passengers, watch out for un-deployed airbags.

Careless cutting can cause unintentional airbag deployment through short-circuits or impact etc., leading to secondary disasters during the rescue operation.

However, if all the airbags have already been deployed, there will not be a problem.

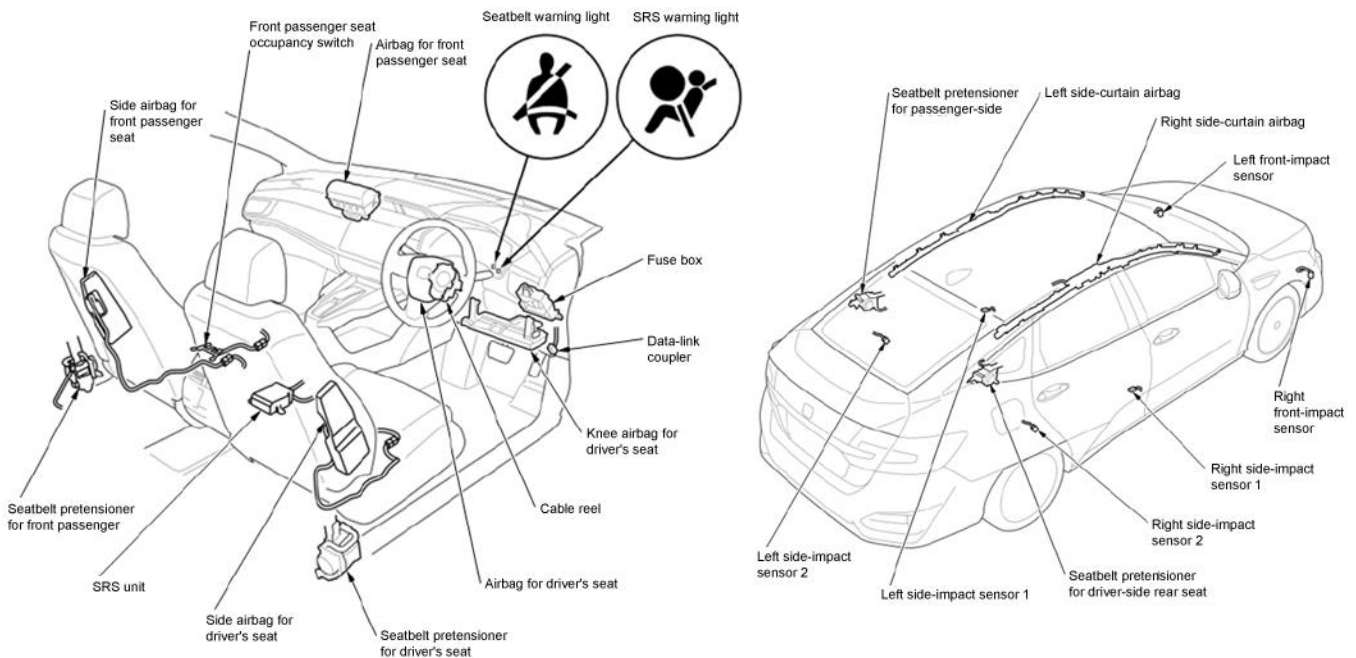

Each airbag and seat-belt pre-tensioner is equipped with a high-pressure gas-generating device.

Try to avoid cutting into these components. Try also to avoid jolting the area around each sensor.

However, if all the airbags have been deployed, or if the power switch is OFF and the 12 V battery has been disconnected for at least 3 minutes, then there will not be a problem.

3. Precautions to be Taken When Responding to a Vehicle Emergency

◆ Precautions regarding high-pressure gas and high voltage

Do not cut into the hydrogen-holding parts, i.e. the fuel-cell system in the motor room, the hydrogen pipe on the underside of the vehicle body, the hydrogen tanks and the regulator under the floor at the rear of the vehicle, and the hydrogen filling pipe on the left wheelhouse.

Do not cut into or near the high-voltage parts, i.e. the high-voltage cables and the lithium-ion battery.

Cutting into the lithium-ion battery should be avoided even after the high-voltage system has been disabled.

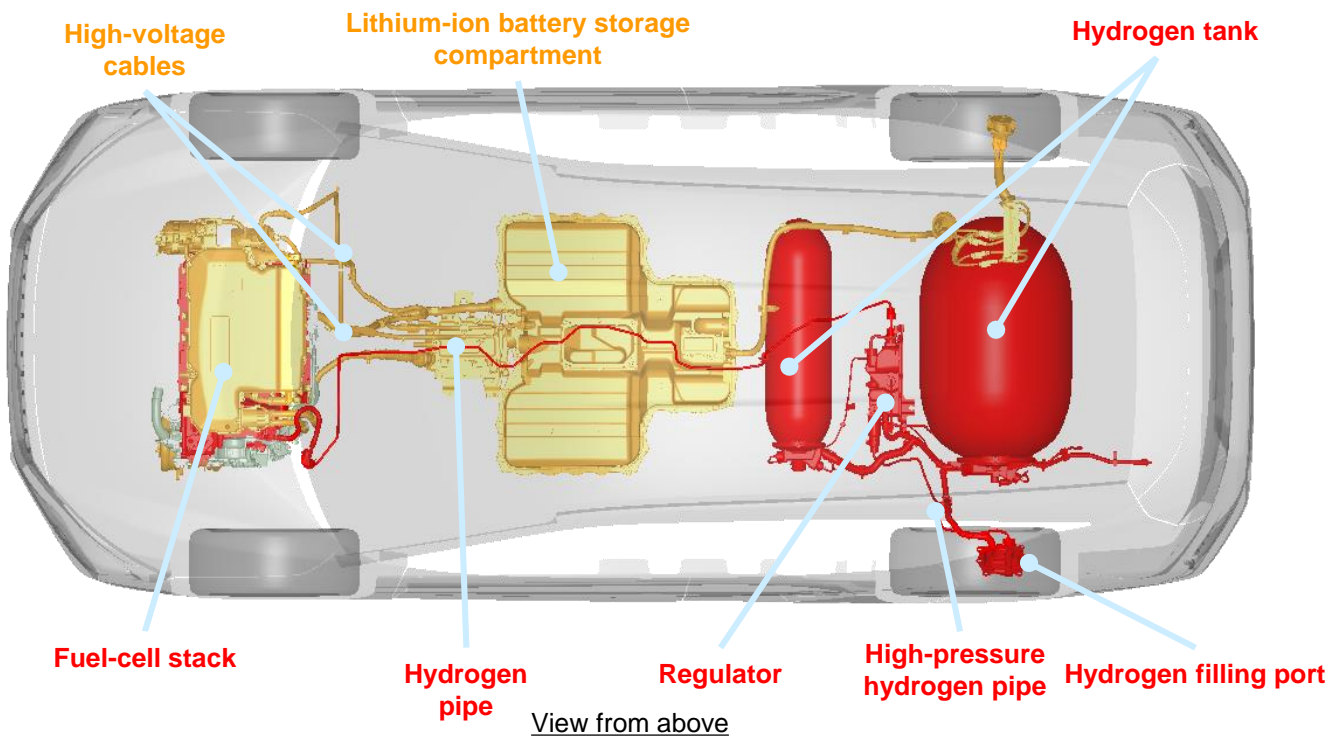

◆ Cut zone

If you need to cut into the vehicle using hydraulic cutters or other tools in order to rescue passengers, do so within the cut zone shown below.

Be especially careful not to cut into areas near the high-pressure gas-generating devices of the side-curtain airbags at the sides of the vehicle (in the no-cut zone).

However, if the side-curtain airbags have already been deployed, there will not be a problem.

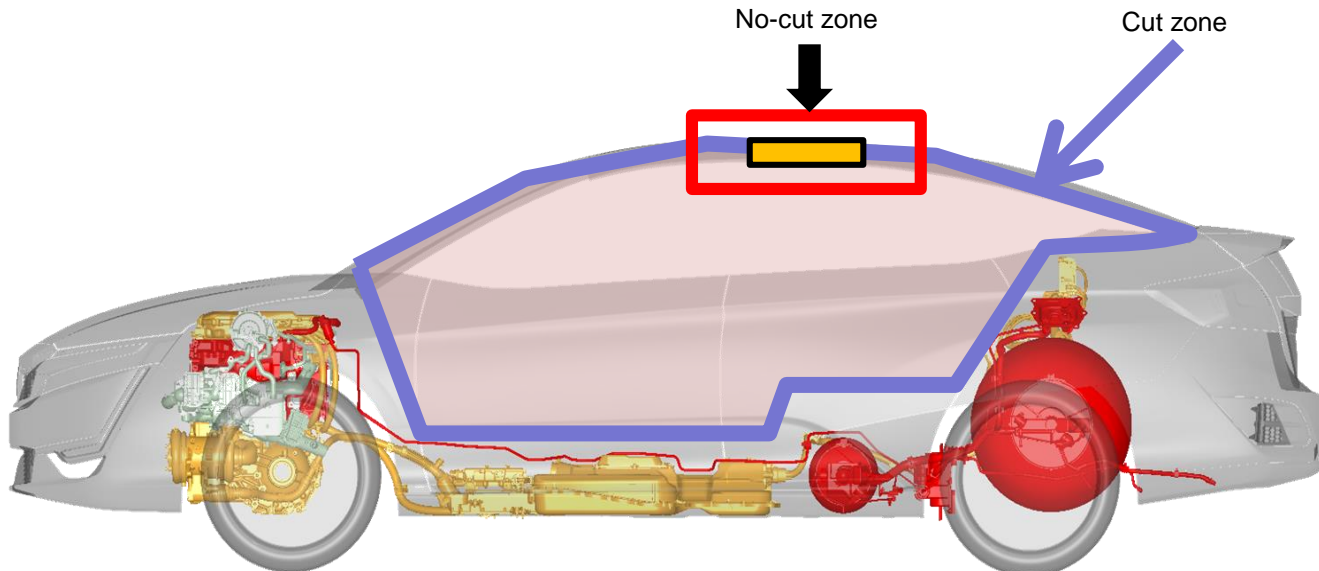

4. Emergency Towing Procedure

Warning

- If orange high-voltage cables or high-voltage covers have been damaged, exposing wiring, terminals or other components, the exposed parts should never be touched. To do so could result in serious injury or death due to severe burns or electric shock.
- If it is not clear whether the exposed wires and terminals are high-voltage components or not, do not touch them.
- If touching high-voltage cables and other high-voltage components is unavoidable, or may happen accidentally, personal insulating protective equipment (insulating gloves, protective goggles and insulating boots) should always be worn.

■ Vehicle Information

Item	Total length (mm)	Total width (mm)	Total height (mm)	Wheelbase (mm)	Weight (kg)
Model					
<i>Clarity Fuel Cell</i>	4,915	1,875	1,480	2,750	1,870

■ Towing Method

Towing should be carried out as follows.

- The vehicle should be towed with all four wheels up.
- The vehicle should not be lifted by its bumper.
- The towing operation should not damage the vehicle.
- The towing operation should comply with road traffic laws.

Tow the vehicle in accordance with the table below.

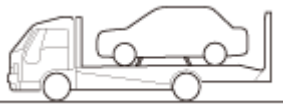
Towing method	Shift-lever position	Conditions and precautions
<ul style="list-style-type: none"> • Towing with all four wheels up 	<p>“P” position</p>	<ul style="list-style-type: none"> • The vehicle must be secured so that it does not protrude from the truck. • The parking brake must be applied.

■ Position of Tie-Down Slots

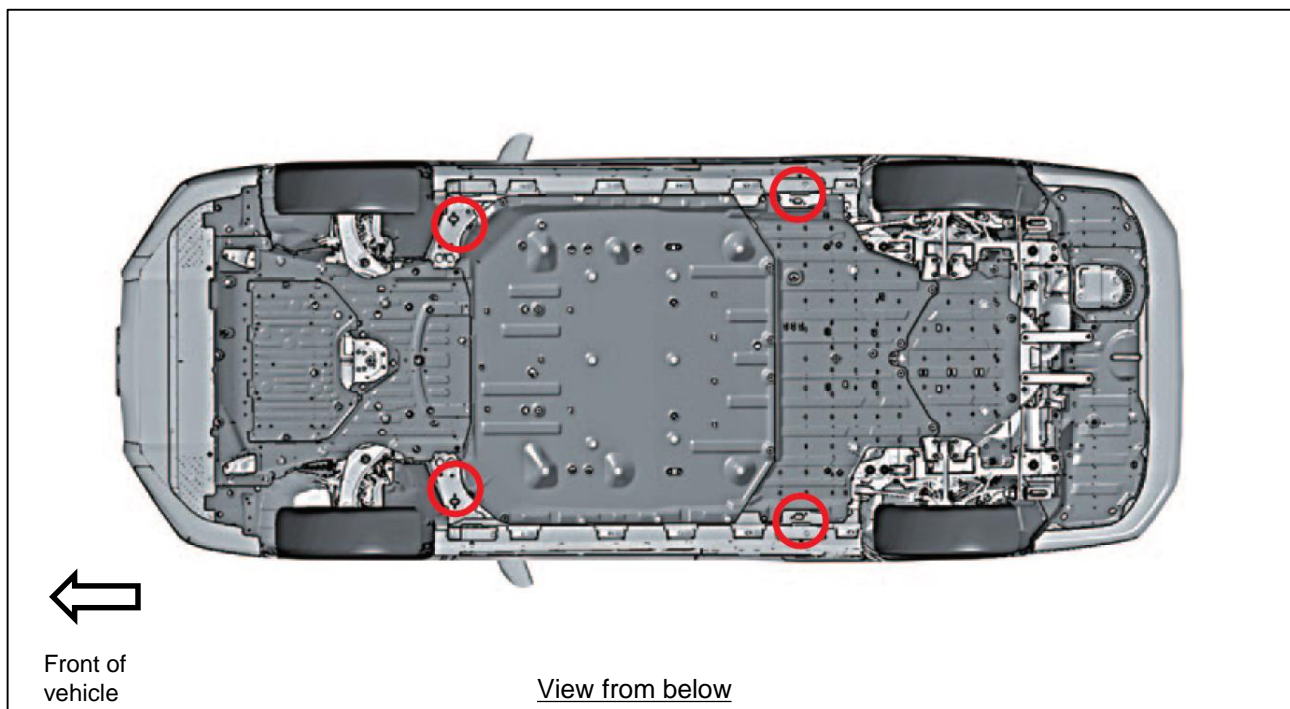

■ Position of Tow Hook

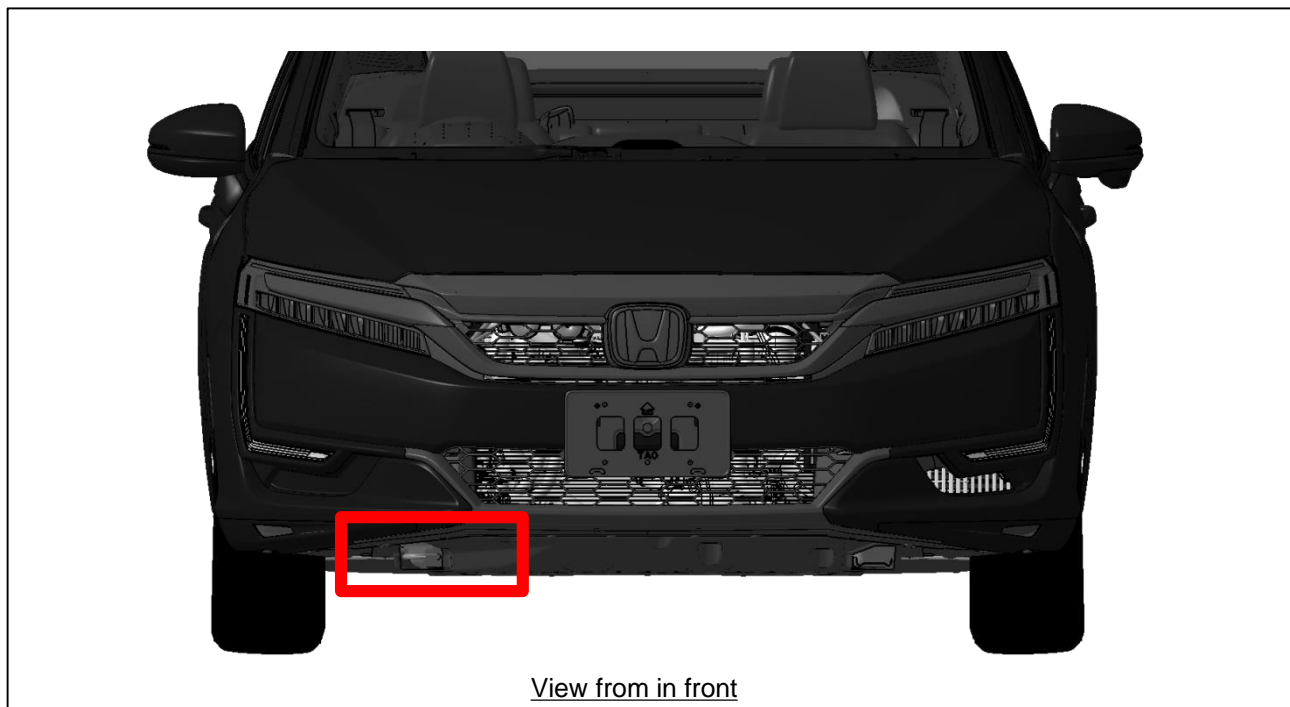

Use this hook when hoisting the vehicle into the breakdown truck.

Note: Avoid towing the vehicle unless for recovery purposes. This can damage the drive motor.

High-Pressure Gas Warning Notice

Person responsible: _____

DO NOT TOUCH!

high-pressure gas work:

Undergoing

Undergoing

high-pressure gas work:

DO NOT TOUCH!

Person responsible: _____

Take a photocopy of this notice, fold it over and display it on the roof of the vehicle in question.

High-Voltage Warning Notice

Person responsible: _____

**Undergoing
high-voltage work:
DO NOT TOUCH!**

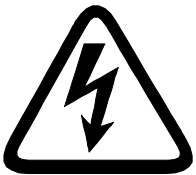
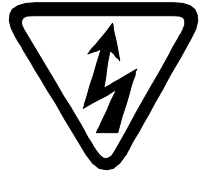

**Undergoing
high-voltage work:
DO NOT TOUCH!**

Person responsible: _____

Take a photocopy of this notice, fold it over and display it on the roof of the vehicle in question.

