

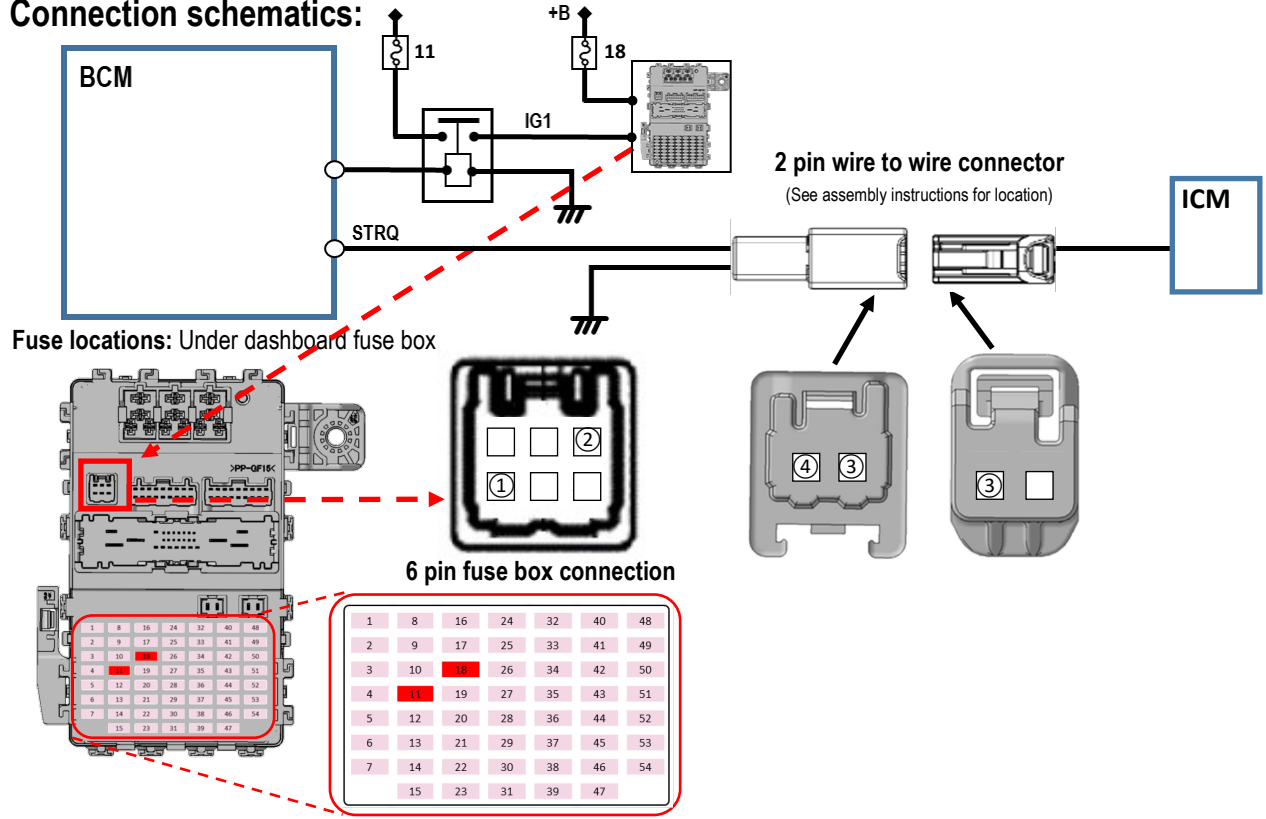

Installation document for alcohol interlocks

Connection schematics:



| | Function | Position of connection |
|---|---|--|
| ① | Battery supply (+B), non blocking (Fuse 18 - limit 20A) | Pin 6 of 6 pin fuse box connection (Male) |
| ② | Ignition power (IG1) (Vehicle ready) (Fuse 11 - limit 10A) | Pin 1 of 6 pin fuse box connection (Male) |
| ③ | Engine operation (Start signal) (STRQ) Prohibits the vehicle from starting if circuit is open. | Pin 1 of 2 pin connector (Male) Pin 1 of 2 pin connector (Female) |
| ④ | Ground | Pin 2 of 2 pin connector (Male) |

Safety risks at installation and items to be considered

When installing on vehicles equipped with airbags, please make sure to never install any devices or wiring in a place that could interfere with the airbag cover parts or airbag operation. In the event of an emergency, it may have a serious impact on passengers.

When installing the alcohol interlock device on the dashboard, install it so that it does not interfere with the drivers view or controls of the vehicle.



Assembly instructions:

(RHD)

Connection point location:

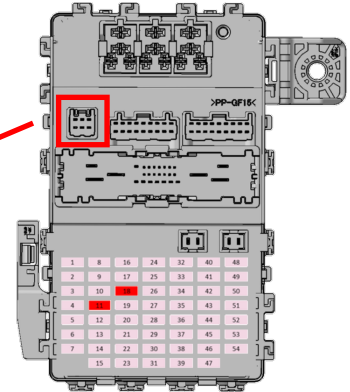
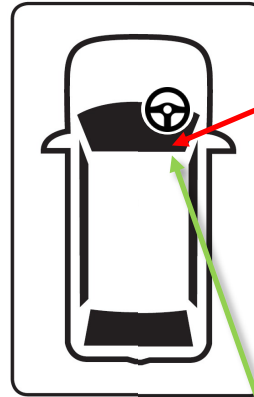

2 pin wire to wire connector

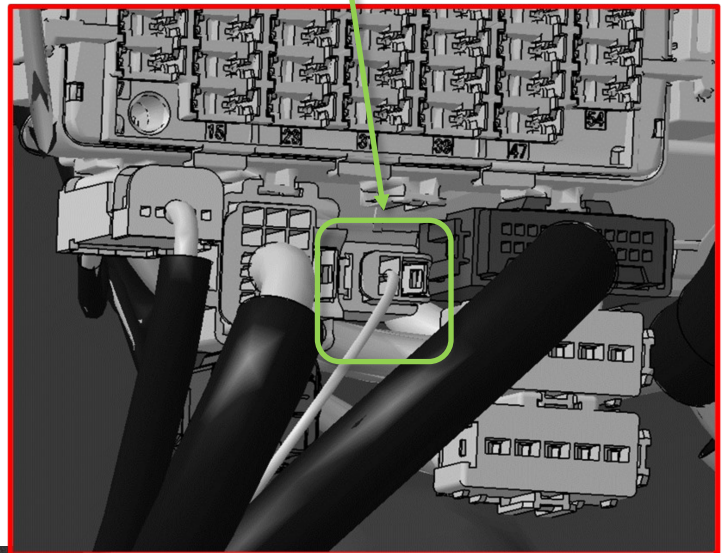

Viewpoint

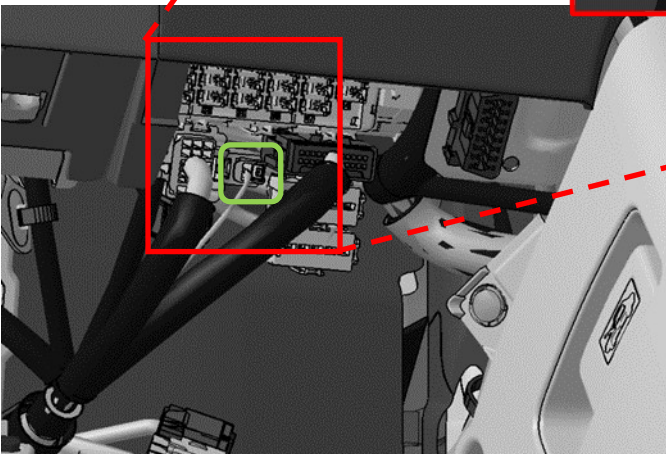



Assembly instructions:

(LHD)

Connection point location:

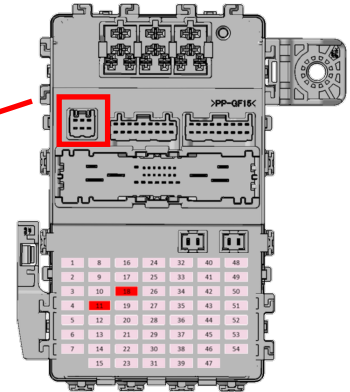
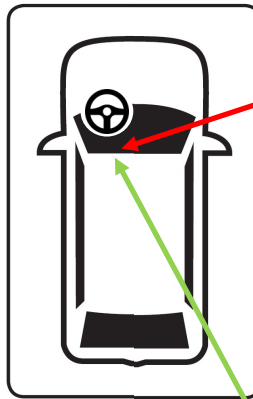

2 pin wire to wire connector

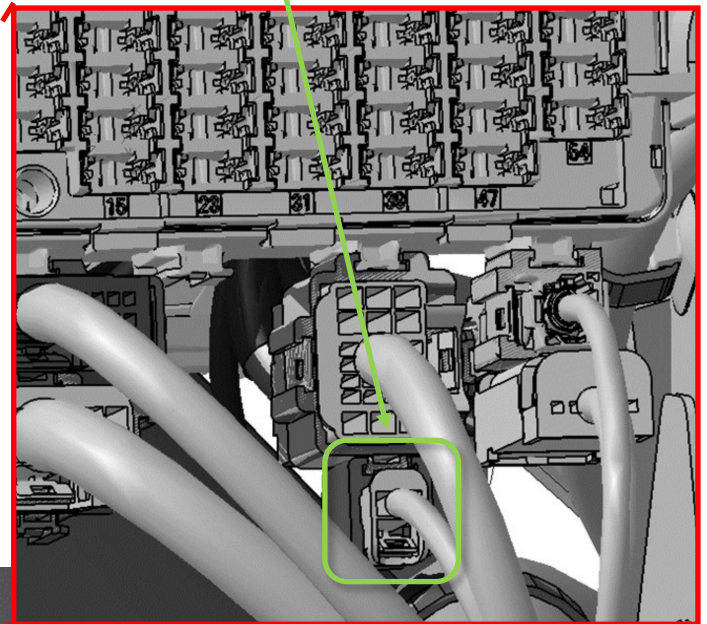

Viewpoint

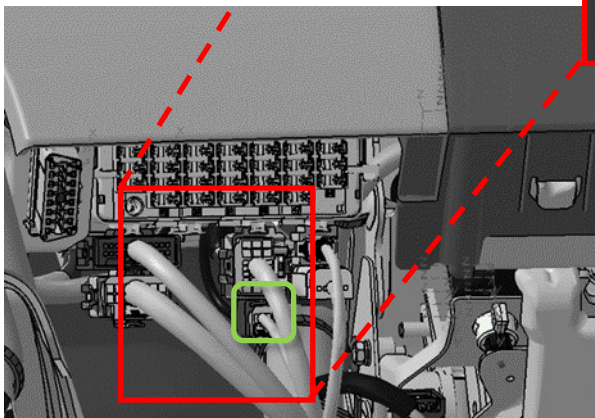



Connection point:

2 pin wire to wire connector.

Disconnect the connector and make the connections between the male and female connectors with compatible connectors and terminals made by YAZAKI.

6 pin fuse box connection

Connect using a female 6 pin connector and terminals made by YAZAKI

Connector type: YAZAKI

7186-8845 (2 pin male)

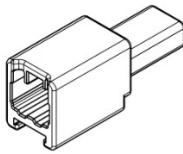

7187-8845 (2 pin female)

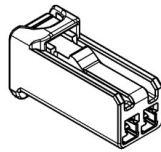

7187-8846 (6 pin female)

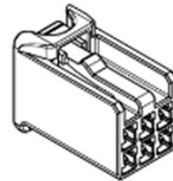

Male Terminals*

7114-7386-02 (S)

7114-7387-02 (M)

7114-7388-02 (L)

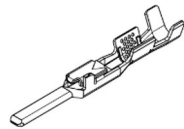

Female Terminals*

7116-7389-02 (S)

7116-7390-02 (M)

7116-7391-02 (L)

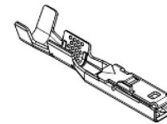

*Different sizes by wire gauge

Panel removal:

LHD shown, RHD is a mirror image.

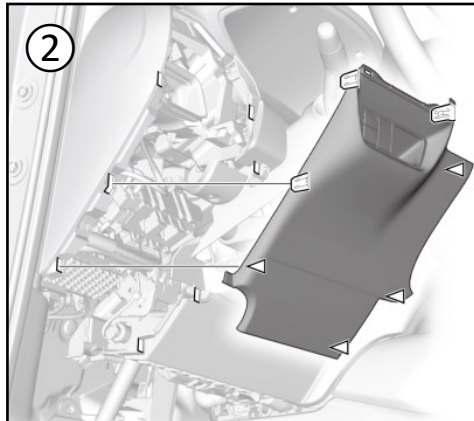
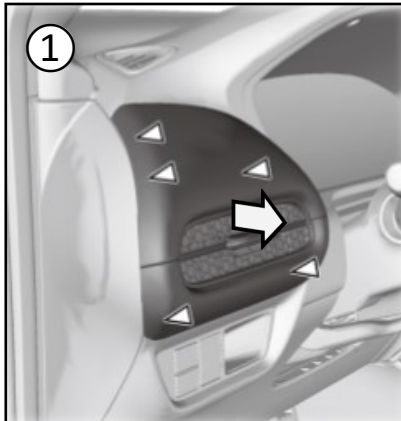

Modification of vehicle operation:

None applicable.

Mounting position of alcohol interlock handset and alcohol interlock control unit:

Recommended installation position:

Install in a position that does not interfere with driving operations or visibility.

Positions where it should not be installed:

Do not install in the airbag deployment area.